



Magnetic Autocontrol GmbH

Grienmatt 20
D-79650 Schopfheim
Tel. 07622 6955

Job number 5526,0005
Customer MHTM
Commission MicroDrive
End customer / Place of installation

Type MHTM - MicroDrive - key switch/switch button

Number of pages 5

				28.02.2011
02	13.04.15	5K15502	gp	gp
01	16.11.11	5K11561	gp	
Version	Date	Modification project	Name	00 5K10565

MHTM
MicroDrive



Cover sheet

5526,0005

A1

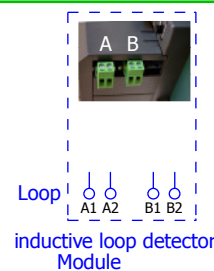
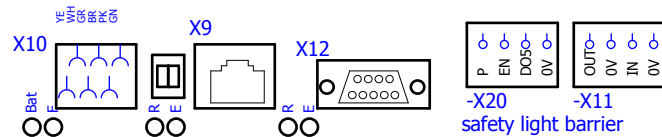

barrier controller MGC

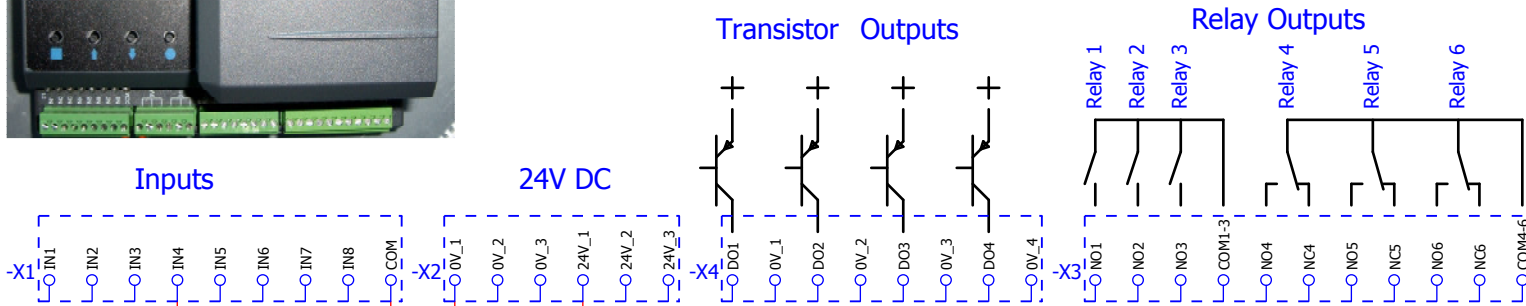

open high priority

-S1
1031,5817



A1

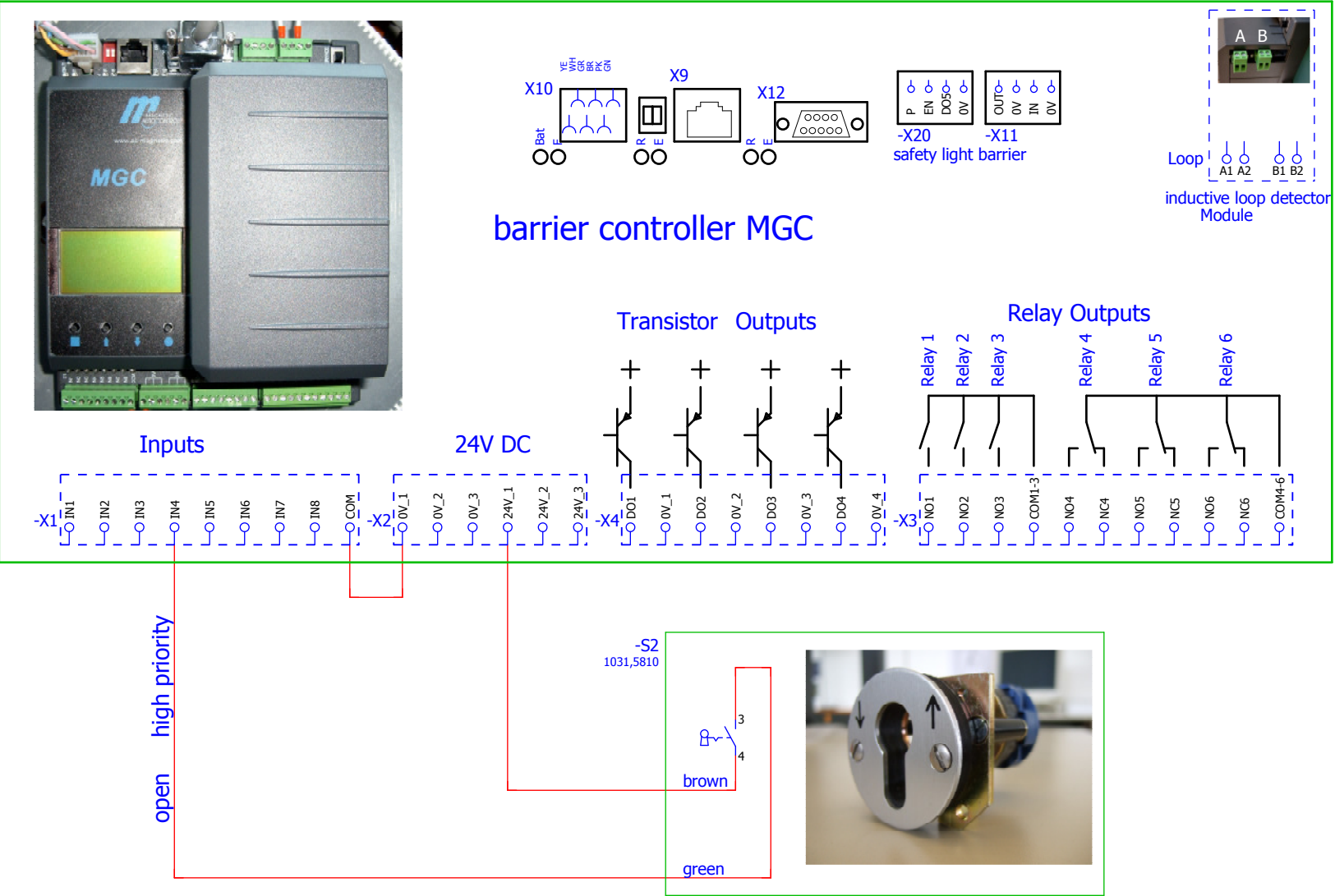

				28.02.2011
02	13.04.15	5K15502	gp	gp
01	16.11.11	5K11561	gp	
Version	Date	Modification project	Name	00 5K10565

MHTM
MicroDrive



key switch open

5526,0005

A1

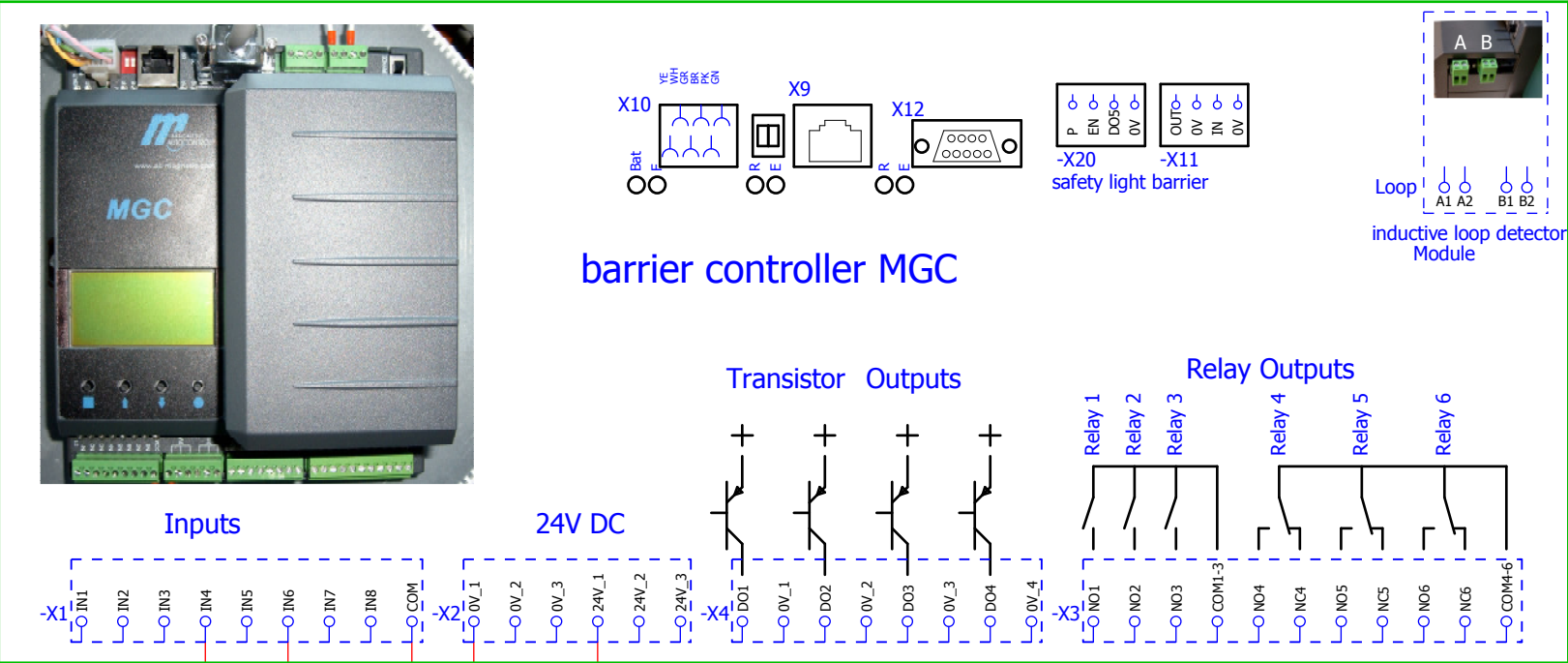

barrier controller MGC

Transistor Outputs

Relay Outputs

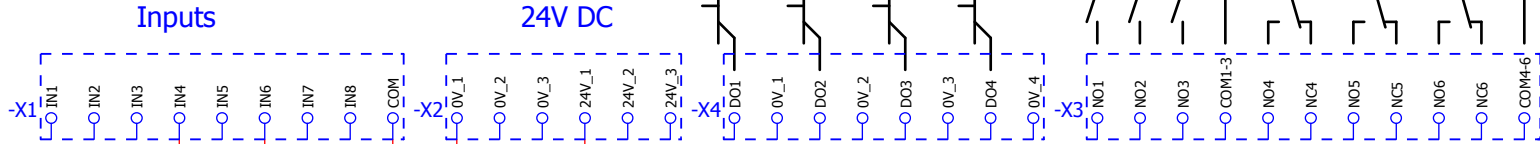

open high priority

close

24V

-S3
1031,5810

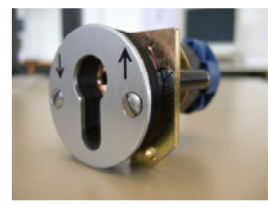
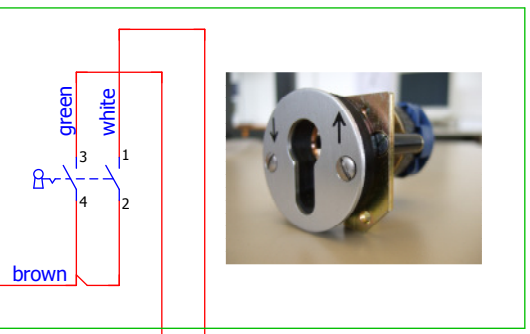

Version	Date	Modification project	Name	00 5K10565
02	13.04.15	5K15502	gp	gp
01	16.11.11	5K11561	gp	

28.02.2011
MHTM
MicroDrive



by pressing a button to close /maintained cont.to open

5526,0005

A1

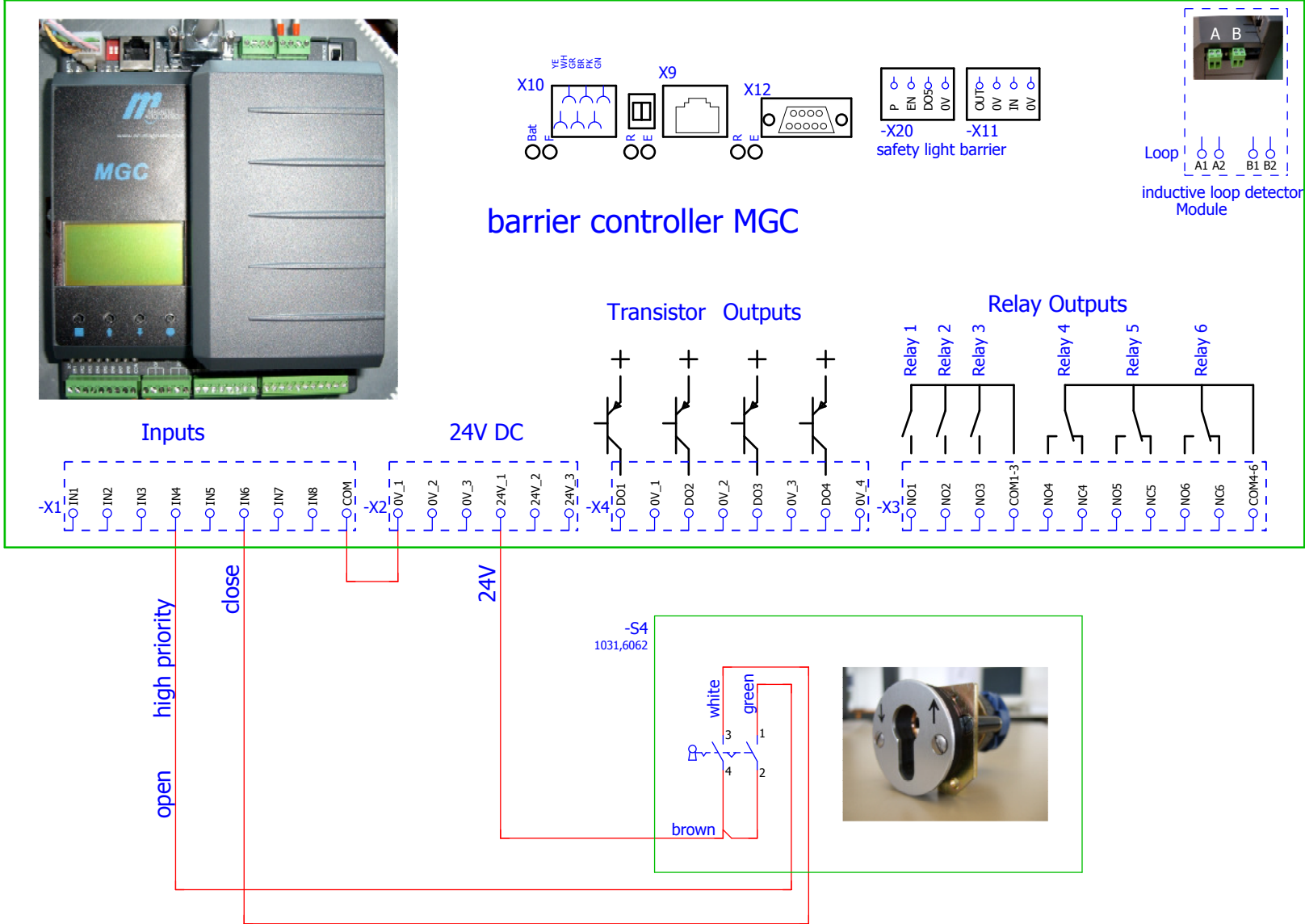

02	13.04.15	5K15502	gp	28.02.2011
01	16.11.11	5K11561	gp	
Version	Date	Modification project	Name	00 5K10565

MHTM
MicroDrive



open /close
maintainend - contact